

Assure global supply chains. Link by link.

Supply chain resilience and legislative compliance cannot be built on predictions. **SUPPLIERASSURANCE** provides the most rigorous supplier due diligence to assure global supply chains from finished products to raw materials, one link at a time.

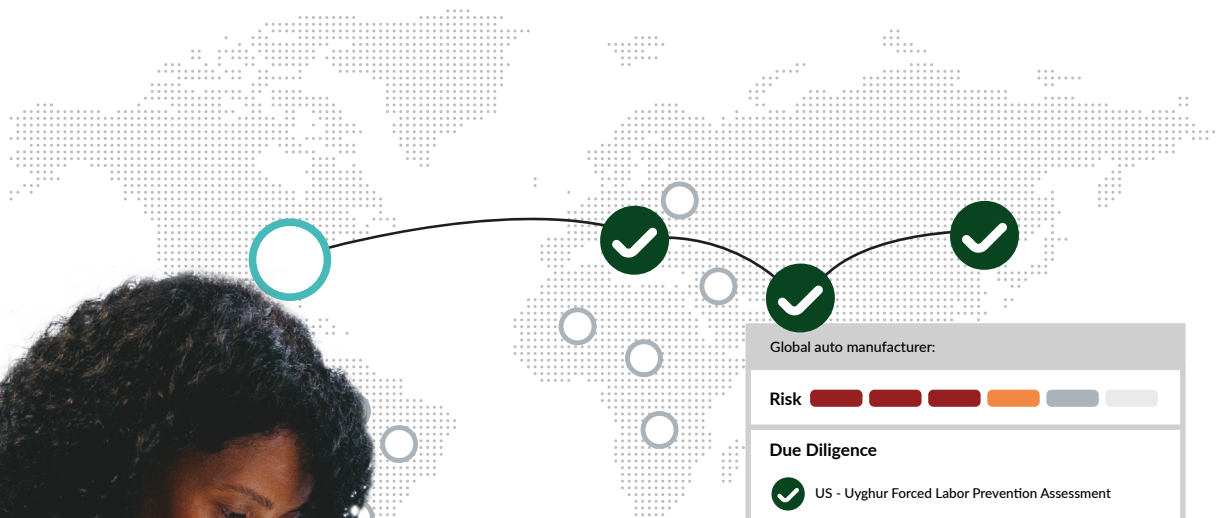

Global auto manufacturer:

Risk

Due Diligence

- US - Uyghur Forced Labor Prevention Assessment
- EU - Battery Assessment
- EU - Deforestation Assessment



Meeting the challenge of legislative compliance.

As regulations such as the Uyghur Forced Labor Prevention Act (UFLPA), EU Battery Regulation (EUBR), and EU Deforestation Regulation (EUDR) reshape global supply chain standards, companies face severe penalties for non-compliance. These regulations demand:

- ✔ Comprehensive supply chain visibility to trace the origins of raw materials.
- ✔ A demonstrable due diligence system to ensure products are free from forced labor and other ESG violations.

Assumptions and predictions won't satisfy these demands. Organizations require evidence-backed, defensible due diligence.

A. Due Diligence System Information

Documentation showing a due diligence system or process that may include the following:

- Engagement with suppliers and other stakeholders to assess and address forced labor risk;
- Mapping of the supply chain and assessment of forced labor risks along the supply chain from raw materials to production of the imported good

U.S. Customs and Border Protection
Operational Guidance for Importers,
June 13, 2022

EU Battery Regulation

L 150/214 EN Official Journal of the European Union 9.6.2023

On the basis of a systemic approach, operators should take the appropriate steps in order to ensure that the relevant products that they intend to place on the market comply with the deforestation-free and legality requirements of this Regulation. To that end, operators should establish and implement due diligence systems. Those due diligence systems should include three elements, namely information requirements, risk assessment and risk mitigation measures, complemented by reporting obligations. The due diligence systems should be designed to provide access to information about the sources and suppliers of the commodities and products being placed on the market, including information demonstrating that the absence of deforestation and forest degradation and legality requirements are fulfilled, inter alia, by identifying the country of production or parts thereof and including the geolocation coordinates of relevant plots of land.

EU Deforestation Regulation

L 150/214 EN Official Journal of the European Union 9.6.2023

Article 49 Economic operator's management system

1. Each economic operator referred to in Article 48(1) shall:
 - (d) establish and operate a system of controls and transparency regarding the supply chain, including a chain of custody or traceability system, identifying upstream actors in the supply chain;
2. The system referred to in paragraph 1, point (d), shall be supported by documentation that provides at least the following information:
 - (a) a description of the raw material, including its trade name and type;
 - (b) the name and address of the supplier that supplied the raw material present in the batteries to the economic operator that places the batteries containing the raw material in question on the market;
 - (c) the country of origin of the raw material and the market transactions from the raw material's extraction to the immediate supplier to the economic operator that places the battery on the market;

Office of Trade Guidance on Executive Summaries and Sample Tables of Contents: Preparing a UFLPA Applicability Review Submission

Generally, to demonstrate that the UFLPA does not apply to a shipment targeted for examination under the law, importers will need to provide documentation produced in the ordinary course of business that details the order, purchase, manufacture, and transportation of inputs throughout their supply chain. CBP considers the totality of information provided by an importer to assess...

Preparing a UFLPA Applicability
Review Submission, Office of Trade

Clarity in supply chain risk.

In line with OECD guidance, today's legislation requires organizations to identify, assess, and prioritize potential risks within their supply chains. Utilizing powerful AI models, SUPPLIERASSURANCE provides a comprehensive, real-time picture of supply chain risk in minutes, equipping organizations with the actionable insights needed to proactively address issues and focus due diligence where it's needed most.



Compliance requires evidence, not assumptions.

Manually meeting legislative requirements with independently verified evidence is complex and time-consuming. AI solutions alone cannot provide the level of accuracy required to meet legislative requirements. SUPPLIERASSURANCE uniquely meets the demands of legislation, providing unparalleled data assurance and equipping organizations with defensible due diligence for resilience and compliance.



Supplier-led mapping

We gather data directly from suppliers, providing accurate visibility across all tiers.



Independent verification

All evidence is verified to ensure alignment with regulations.



Sub-tier anonymization

Protect commercial relationships by keeping sub-tier identities anonymous while maintaining visibility.



Alignment with legislation

Our assessments are developed with experts to meet current and emerging legislative requirements.



Compliant evidence set

Generate comprehensive reports to demonstrate compliance with authorities quickly and easily.

MINE for risks while you MAP for assurance.

SUPPLIERASSURANCE provides a robust approach to legislative compliance aligned with OECD guidance, enabling organizations to **MINE** vast supply chain networks, **SURVEIL** risk, and engage suppliers directly to **MAP** and **ASSURE** at-risk chains. This unique combination delivers comprehensive, defensible due diligence for streamlined compliance.

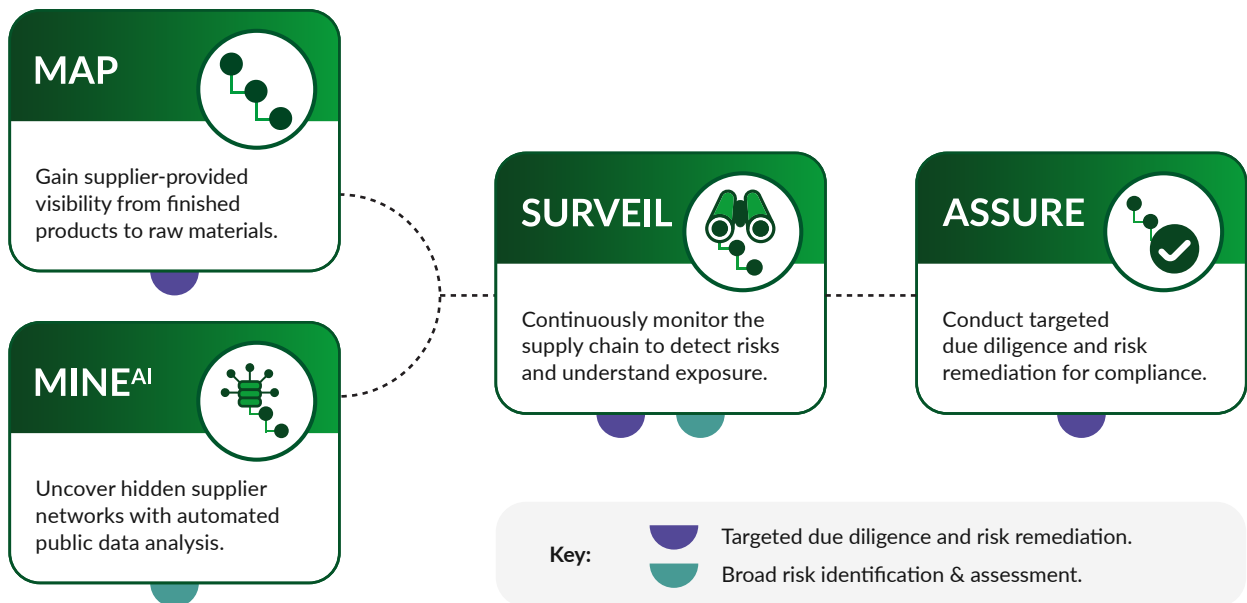

MINE^{AI}: Unearth hidden supply chain networks.

Leveraging automated data mining and artificial intelligence, SUPPLIERASSURANCE: MINE^{AI} unearths hidden supply chain networks, mapping complex connections at unmatched speed. MINE^{AI} identifies indirect relationships across corporate hierarchies and sub-tiers, highlighting parent, sister, and associated companies that may impact risk. Combined with SURVEIL, MINE^{AI} offers a comprehensive view of risk to enable targeted due diligence.

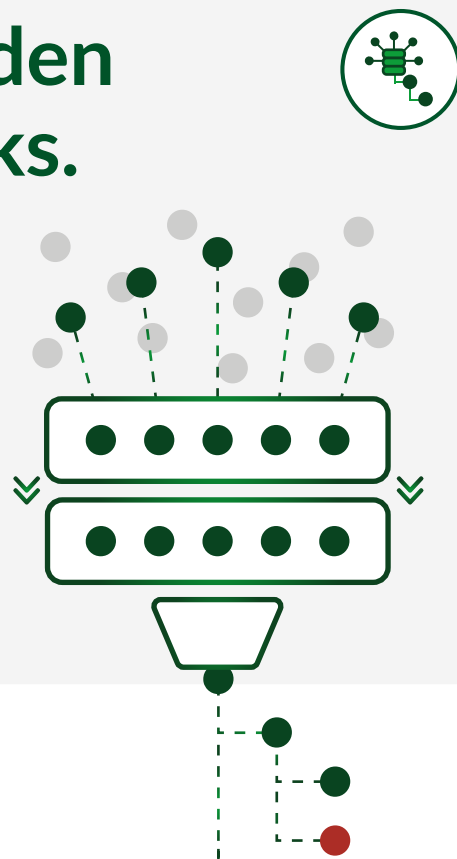

MAP: Visibility built on precision, not assumptions.

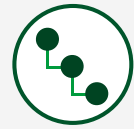

Demonstrating supply chain visibility to regulatory bodies requires both precision and efficiency. **SUPPLIERASSURANCE: MAP** uses a scalable, supplier-led approach to efficiently map complex, multi-tier supply chains, streamlining sub-tier mapping to drive shared responsibility and ensure accuracy.

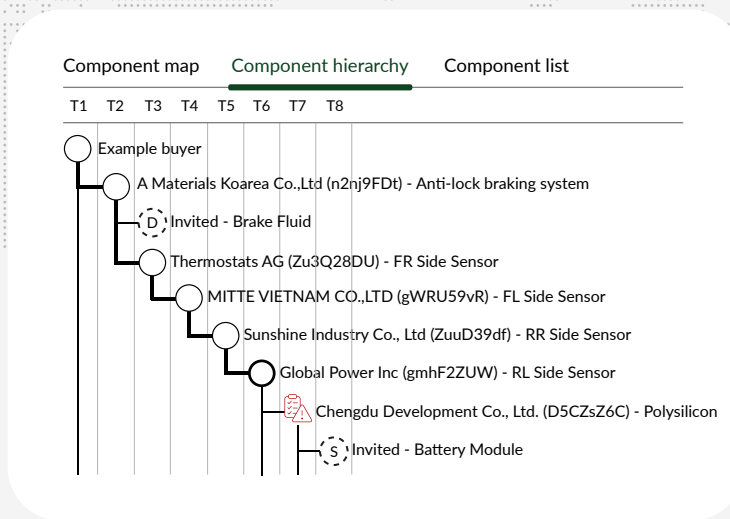

Effortless scalability: Adaptable for global operations.

SUPPLIERASSURANCE: MAP scales effortlessly, enabling organizations to map complex, multi-tier supply chains while ensuring every supplier is accountable. Our platform simplifies the process for suppliers to map their sub-tiers, driving shared responsibility and maintaining accuracy.

Upload full or partial supplier data

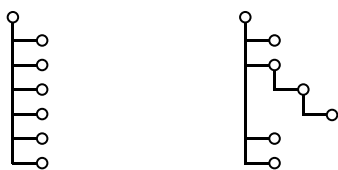

Upload tier-1 data

Upload complex multi-tier data

Autonomously build and maintain your supply chain map

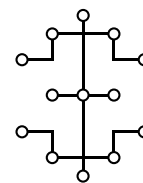

SUPPLIERASSURANCE: MAP traverses global supply chains, engaging suppliers to provide accurate, supplier-led data and autonomously building sub-tier networks.

SURVEIL: Profile risk to target due diligence.



SUPPLIERASSURANCE: SURVEIL ensures supply chain resilience with non-intrusive surveillance and real-time risk intelligence, profiling risks across all tiers.

Using trusted data, **SURVEIL** identifies threats—from geopolitical to regulatory—enabling organizations to act quickly and mitigate issues before they disrupt operations.

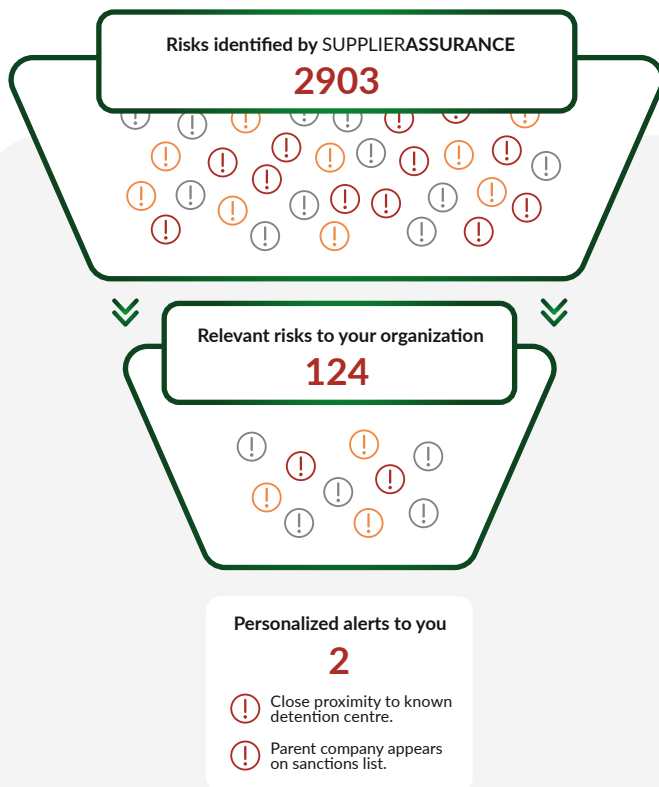
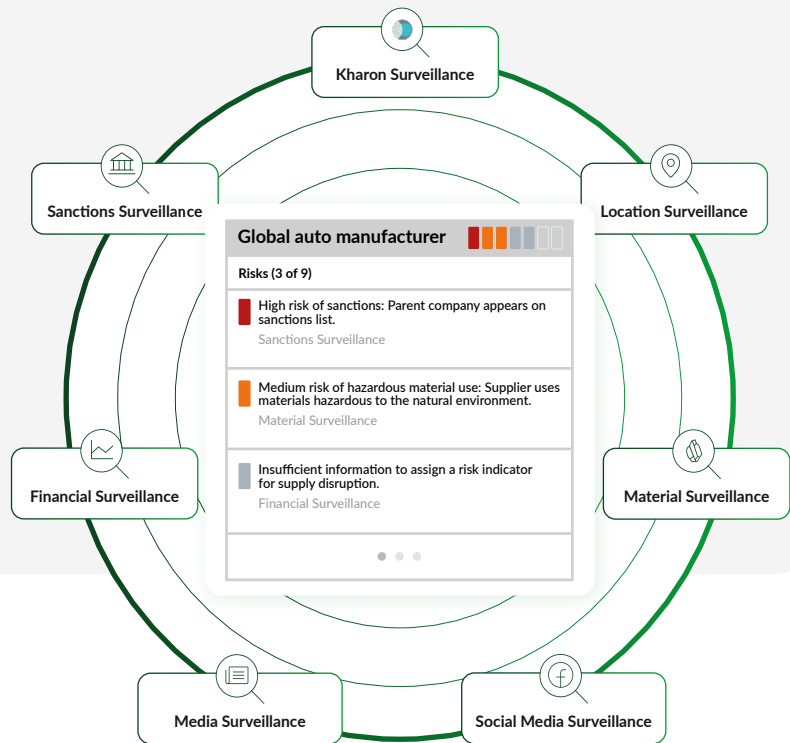

Personalized risk alerts: Reveal with relevance.

With thousands of potential risk events across your supply chain, it's crucial to focus only on what matters. **SUPPLIERASSURANCE: SURVEIL** filters risk notifications by product, risk type, and severity, ensuring you only receive alerts on the most critical issues. This targeted approach helps your team make fast, effective decisions by focusing on high-impact risks to ensure timely compliance.

ASSURE: Targeted due diligence for compliance.



Conduct targeted due diligence for legislative compliance using a proven framework that engages each supplier directly and automates interactions to ensure timely and scalable compliance. With independent verification of evidence, **SUPPLIERASSURANCE: ASSURE** ensures your supply chain remains resilient and compliant, effortlessly guiding suppliers from risk identification to continuous improvement.

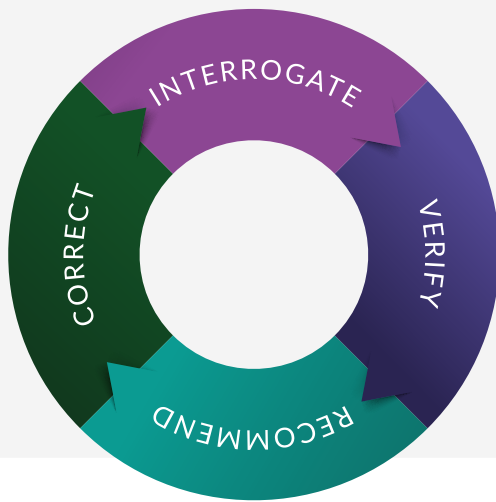

INTERROGATE

Invite suppliers to complete legislation-aligned assessments, collecting and tracking evidence in real-time.

VERIFY

All supplier evidence is independently verified for accuracy and regulatory alignment.

RECOMMEND

Suppliers receive tailored corrective actions, enabling continuous improvement.

CORRECT

Buyers prioritize suppliers' corrective actions to ensure compliance and reporting.

Assessment Library: Aligned with legislation.

Ensure due diligence translates into compliance with best-practice assessments from our growing assessment library, including UFLPA, EUBR, and EUDR assessments. Each assessment is developed alongside legal and consulting experts to align with evolving legislative requirements. **SUPPLIERASSURANCE** delivers ongoing supply chain visibility and defensible due diligence, automatically updating information to create a compliant evidence set ready for regulatory authorities—equipping organizations to demonstrate compliance confidently.



UFLPA Compliance

The UFLPA requires organizations to prove that their supply chains are free from forced labor, particularly in high-risk regions like Xinjiang. Our US - Uyghur Forced Labor Prevention Assessment and US - Commercial Chain of Custody Assessment (CCOCA) collect and verify the evidence needed to demonstrate supply chain visibility and a due diligence system.



EUBR Compliance

The EUBR mandates traceability throughout the battery supply chain, particularly for materials sourced from conflict-affected regions. Our EU - Battery Assessment and CCOCA provide the defensible evidence required to demonstrate full supply chain visibility and compliance.



EUDR Compliance

The EUDR calls for documentation proving that products are not linked to deforestation, particularly in regions with known deforestation risks like the Amazon. Our EU - Deforestation Assessment and CCOCA deliver the evidence needed to meet EUDR standards and demonstrate compliance.

An AIAG Preferred Provider for defensible due diligence.

SUPPLIERASSURANCE is recognized by the Automotive Industry Action Group (AIAG) as a Preferred Provider for defensible due diligence and forced labor compliance.

AIAG's endorsement highlights our commitment to supporting ethical and sustainable supply chains in the automotive industry.



Assure your supply chains.

SUPPLIERASSURANCE is a leader in supply chain risk management, providing global organizations with the tools they need to map, monitor, and mitigate risks across every supply chain tier. Trusted by global automotive OEMs and used across 129,000+ supplier locations, our solutions combine innovation with proven expertise to protect and enhance global supply chains.

Contact SUPPLIERASSURANCE today and let us help you on your sustainability journey.

Scan to book a demo today.

